



PowerBeam™ ac

High-Performance airMAX® Bridge

Models: PBE-5AC-500, PBE-5AC-620

Uniform Beamwidth Maximizes Noise Immunity

Innovative Mechanical Design

High-Speed Processor for Superior Performance



Overview

Ubiquiti Networks launches the latest generation of airMAX® CPE (Customer Premises Equipment), the PowerBeam™ ac.

Improved Noise Immunity

The PowerBeam ac directs RF energy in a tighter beamwidth. With the focus in one direction, the PowerBeam ac blocks or spatially filters out noise, so noise immunity is improved. This feature is especially important in an area crowded with other RF signals of the same or similar frequency.

Integrated Design

Ubiquiti's InnerFeed™ technology integrates the radio into the feedhorn of an antenna, so there is no need for a cable. This improves performance because it eliminates cable losses.

Featuring high performance and innovative mechanical design, the PowerBeam ac is versatile and cost-effective to deploy.

Software

airOS® 7

Sporting an all-new design for improved usability, airOS® v7 is the revolutionary operating system for Ubiquiti® airMAX ac products.

Powerful Wireless Features

- airMAX ac Protocol Support
- Long-Range Point-to-Point (PtP) Link Mode
- Selectable Channel Width
 - PtP: 10/20/30/40/50/60/80 MHz
 - PtMP: 10/20/30/40 MHz
- Automatic Channel Selection
- Transmit Power Control: Automatic/Manual
- Automatic Distance Selection (ACK Timing)
- Strongest WPA2 Security

Usability Enhancements

- Dynamic Configuration Changes
- Instant Input Validation
- HTML5 Technology
- Optimization for Mobile Devices
- Detailed Device Statistics
- Comprehensive Array of Diagnostic Tools, including Ethernet Cabling Test, RF Diagnostics, and airView® Spectrum Analyzer

Application Examples

PtMP Client Links

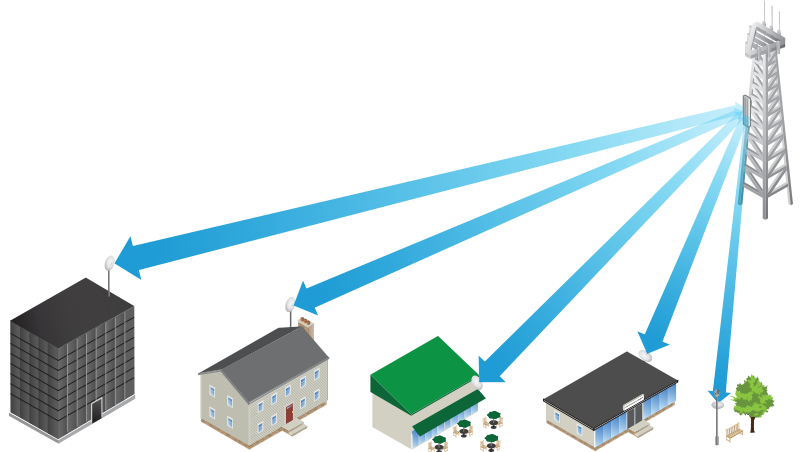

The PowerBeam ac used as a CPE device for each client in an airMAX PtMP network.

Wireless Client



The PowerBeam ac as a powerful wireless client.

PtP Link

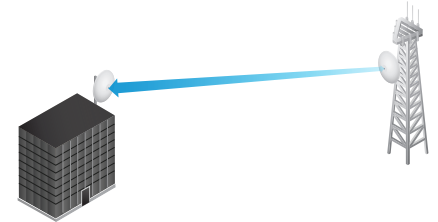

Use a PowerBeam ac on each side of a PtP link.

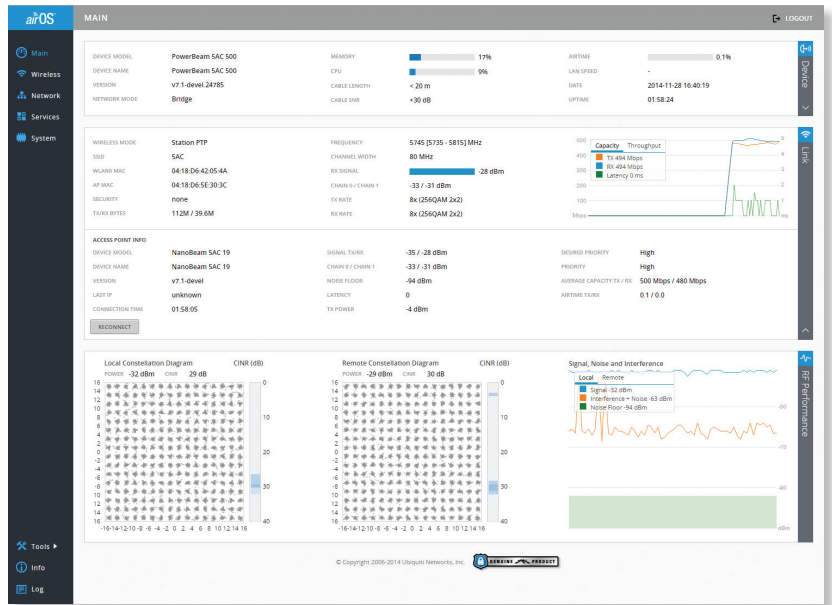

Advanced RF Analytics

airMAX ac devices feature a multi-radio architecture to power a revolutionary RF analytics engine.

An independent processor on the PCBA powers a second, dedicated radio, which persistently analyzes the full 5 GHz spectrum and every received symbol to provide you with the most advanced RF analytics in the industry.

Data from the spectrum analysis and RF performance monitoring is displayed on the *Main* tab and airView Spectrum Analyzer of airOS v7.

Real-Time Reporting

The *Main* tab displays the following RF information:

- Persistent RF Error Vector Magnitude (EVM) constellation diagrams
- Carrier to Interference-plus-Noise Ratio (CINR) histograms
- Signal-to-Noise Ratio (SNR) time series plots

Spectral Analysis

airView allows you to identify noise signatures and plan your networks to minimize noise interference. airView performs the following functions:

- Constantly monitors environmental noise
- Collects energy data points in real-time spectral views
- Helps optimize channel selection, network design, and wireless performance

airView runs in the background without disabling the wireless link, so there is no disruption to the network.

In airView, there are three spectral views, each of which represents different data.

- **Waterfall** Aggregate energy collected for each frequency
- **Waveform** Aggregate energy collected
- **Ambient Noise Level** Background noise energy shown as a function of frequency

Available with a firmware upgrade to airOS v7.1, airView provides powerful spectrum analyzer functionality, eliminating the need to rent or purchase additional equipment for conducting site surveys.

Multi-Radio Architecture

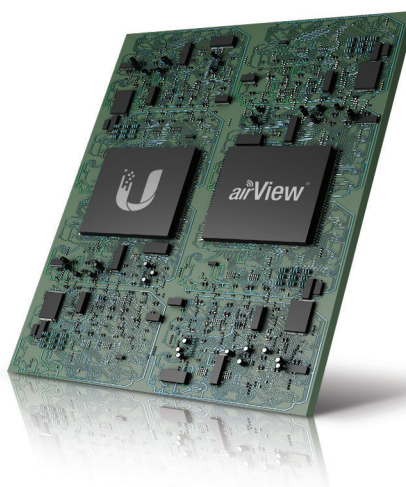

Constellation Diagrams and CINR Histograms

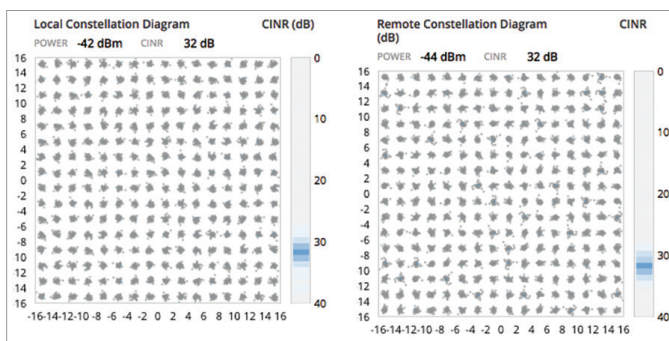

SNR Time Series Plots

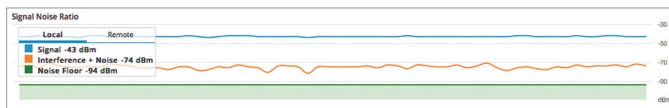

Dedicated Spectral Analysis



airCRM™

Powerfully scale your business with airCRM™, a suite of WISP applications that help you manage your business. To sign up for the public beta, visit: aircrm.ubnt.com

airCRM™ Control

Provision, monitor, and manage all devices from a central interface. Enjoy quicker deployments, healthier networks, and faster customer service response times.

Use airCRM Control to perform the following tasks:

- Upgrade firmware
- Manage passwords
- Monitor and analyze network traffic
- Manage devices

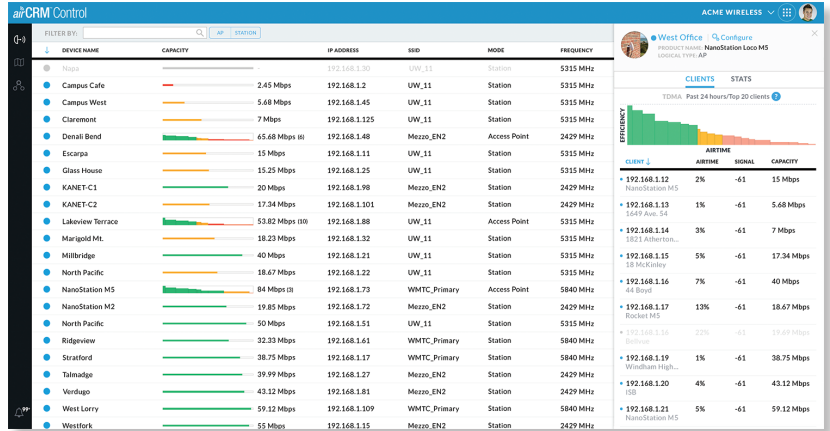

airCRM™ Billing

A streamlined billing and customer management solution delivers automated invoicing, payment reminders, and credit card processing with Authorize.Net.

Use airCRM Billing to perform the following tasks:

- Create invoices
- Manage accounts
- Enable a customer portal
- Generate detailed reports

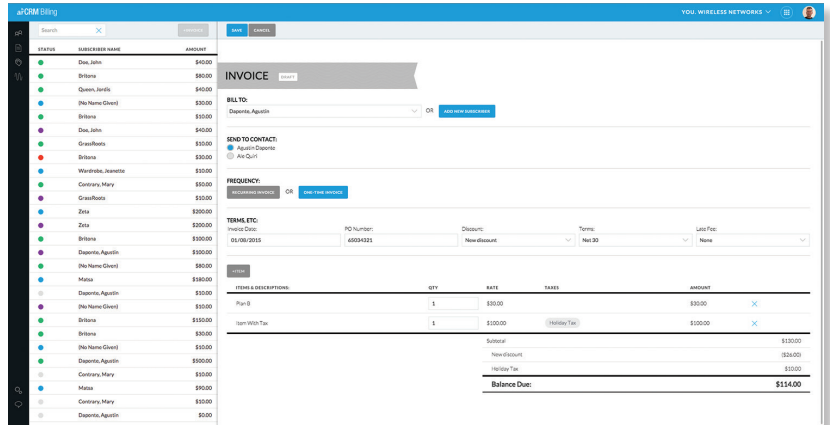

Technology



Unlike standard Wi-Fi protocol, Ubiquiti's Time Division Multiple Access (TDMA) airMAX protocol allows each client to send and receive data using pre-designated time slots scheduled by an intelligent AP controller.

This time slot method eliminates hidden node collisions and maximizes airtime efficiency, so airMAX technology provides performance improvements in latency, noise immunity, scalability, and throughput compared to other outdoor systems in its class.

Intelligent QoS Priority assigned to voice/video for seamless streaming.

Scalability High capacity and scalability.

Long Distance Capable of high-speed, carrier-class links.

Superior Performance

The next-generation airMAX ac technology boosts the advantages of our proprietary TDMA protocol.

Ubiquiti's airMAX engine with custom IC dramatically improves TDMA latency and network scalability. The custom silicon provides hardware acceleration capabilities to the airMAX scheduler, to support the high data rates and dense modulation used in airMAX ac technology.

Throughput Breakthrough

airMAX ac supports high data rates, which require dense modulation: 256QAM – a significant increase from 64QAM, which is used in airMAX.

With their use of proprietary airMAX ac technology, airMAX ac products supports up to 450+ Mbps real TCP/IP throughput – up to triple the throughput of standard airMAX products.

airMAX ac TDMA Technology

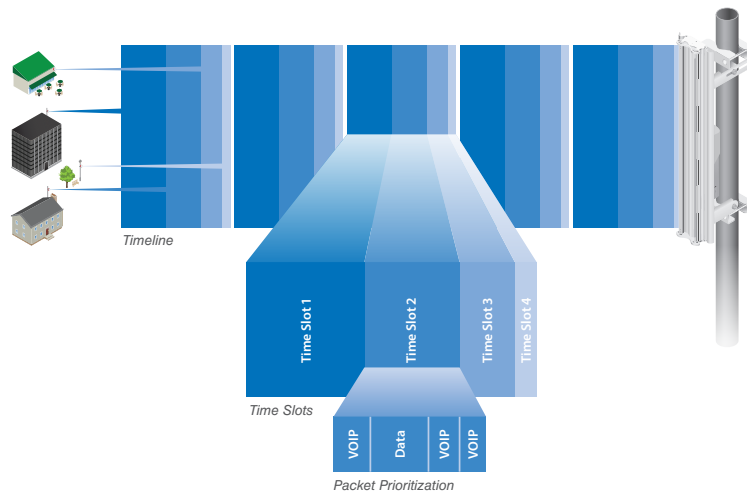

Up to 100 airMAX ac stations can be connected to an airMAX ac Sector; four airMAX ac stations are shown to illustrate the general concept.

airMAX Network Scalability

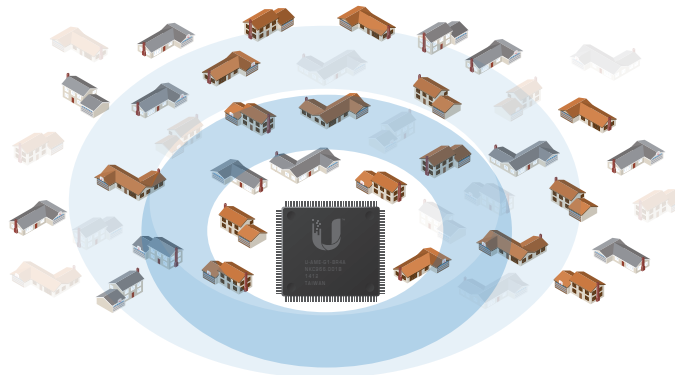

Superior Throughput Performance

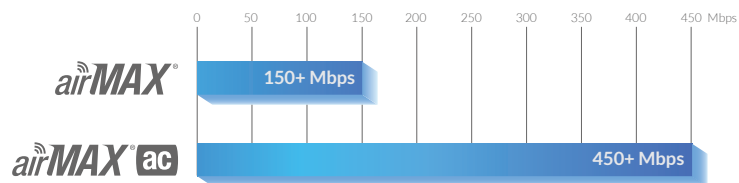

Hardware Overview

Innovative Mechanical Design

- **Built-in mechanical tilt** The mounting bracket of the PBE-5AC-500 offers 20° of uptilt and 10° of downtilt, while the mounting bracket of the PBE-5AC-620 offers ± 15° of tilt.
- **Convenient pole-mounting** Only a single wrench is needed to mount the PowerBeam ac on a pole.
- **Easy removal** The antenna feed can be detached with the push of a button.

Industrial-Strength Construction

- **Fasteners** GEOMET-coated for improved corrosion resistance when compared with zinc-plated fasteners.
- **Dish and brackets** Made of galvanized steel that is powder-coated for superior corrosion resistance. The pole bracket design prevents paint from being removed from the metal brackets for improved corrosion resistance.
- **Protective radome (PBE-5AC-500 only)** Shields the radio from the elements.

Models

Using airMAX ac technology, the PowerBeam ac supports up to 450+ Mbps real TCP/IP throughput. Available in two models, the PowerBeam ac launches with PtP functionality, and a client mode feature will be added with a future firmware upgrade.



PowerBeam™ ac

Model	Frequency	Gain	Dish Reflector
PBE-5AC-500	5 GHz	27 dBi	500 mm



PowerBeam™ ac

Model	Frequency	Gain	Dish Reflector
PBE-5AC-620	5 GHz	29 dBi	620 mm

PowerBeam™ ac

Accessories

IsoBeam™

Model: ISO-BEAM-620



The IsoBeam™ is an isolator radome that is available as an optional accessory for the PBE-5AC-620 and other models:

- PowerBeam PBE-M5-620
- RocketDish™ RD-5G30-LW

The innovative RF-choke perimeter of the IsoBeam delivers superior noise immunity in co-location deployments; its perimeter corrugation provides enhanced RF shielding. Compare the two near-field plots below, and note the breakthrough isolation performance of the IsoBeam.

Both near-field plots are displayed in watts and use a linear scale. The strength of the electromagnetic field is color-coded:

- Red: Highest strength
- Green: Medium strength
- Indigo: Lowest strength

Without IsoBeam

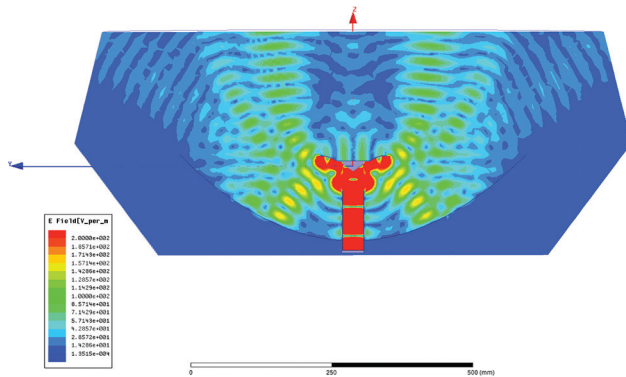

With IsoBeam

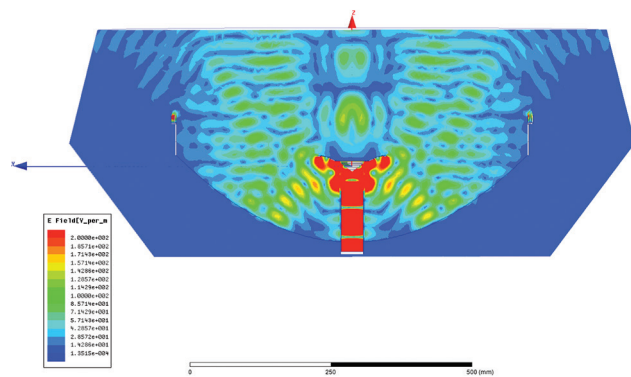

Precision Alignment Kit

Model: PAK-620

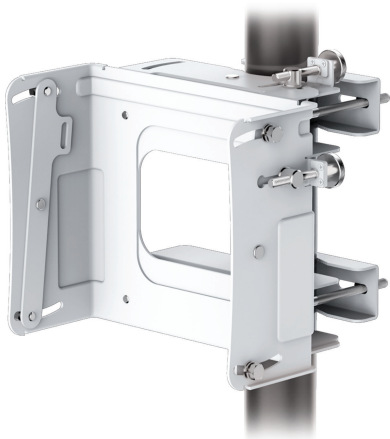

The Precision Alignment Kit is available as an optional accessory for the PBE-5AC-620. It features 15° of azimuth adjustment and 15° of elevation adjustment to enable extremely accurate aiming for optimal PtP link performance.

The Precision Alignment Kit is also compatible with other dish antennas:

- airFiber® AF-5G30-S45
- PowerBeam PBE-M5-620
- RocketDish RD-5G30-LW

Specifications

PBE-5AC-500 System and Regulatory/Compliance	
Processor Specs	Atheros MIPS 74Kc, 720 MHz
Memory	128 MB DDR2, 8 MB Flash
Networking Interface	(1) 10/100/1000 Ethernet Port
Wireless Approvals	FCC, IC, CE
RoHS Compliance	Yes

PBE-5AC-500 Physical/Electrical/Environmental	
Dimensions	
Radome Excluded	520 x 520 x 308 mm (20.47 x 20.47 x 12.13")
Radome Included	525 x 525 x 315 mm (20.67 x 20.67 x 12.40")
Weight	
Radome Excluded	2.35 kg (5.18 lb)
Radome Included	3.15 kg (6.95 lb)
Power Supply	24V, 0.5A Gigabit PoE
Power Method	Passive PoE (Pairs 4, 5+; 7, 8 Return)
Supported Voltage Range	20-26VDC
Max. Power Consumption	8.5W
Gain	27 dBi
Operating Frequency	
Worldwide	5150 - 5875 MHz
USA	5725 - 5850 MHz
Wind Loading	419.6 N @ 200 km/h (94.33 lbf @ 125 mph)
Wind Survivability	200 km/h (125 mph)
LEDs	(1) Power, (1) LAN, (4) WLAN
Signal Strength LEDs	Software-Adjustable to Correspond to Custom RSSI Levels
Channel Sizes	
PtP Mode	10/20/30/40/50/60/80 MHz
PtMP Mode	10/20/30/40 MHz
Polarization	Dual Linear
Enclosure	Outdoor UV Stabilized Plastic
Mounting	Pole-Mount Kit Included
ESD/EMP Protection	Air: ± 24 kV, Contact: ± 24 kV
Operating Temperature	-40 to 70° C (-40 to 158° F)
Operating Humidity	5 to 95% Non-Condensing
Salt Fog Test	IEC 68-2-11 (ASTM B117), Equivalent: MIL-STD-810 G Method 509.5
Vibration Test	IEC 68-2-6
Temperature Shock Test	IEC 68-2-14
UV Test	IEC 68-2-5 at 40° C (104° F), Equivalent: ETS 300 019-1-4
Wind-Driven Rain Test	ETS 300 019-1-4, Equivalent: MIL-STD-810 G Method 506.5

Specifications

PBE-5AC-500 Output Power: 22 dBm							
TX Power Specifications				RX Power Specifications			
Modulation	Data Rate	Avg. TX	Tolerance	Modulation	Data Rate	Sensitivity	Tolerance
airMAX ac	1x BPSK (1/2)	22 dBm	± 2 dB	airMAX ac	1x BPSK (1/2)	-96 dBm	± 2 dB
	2x QPSK (1/2)	22 dBm	± 2 dB		2x QPSK (1/2)	-95 dBm	± 2 dB
	2x QPSK (3/4)	22 dBm	± 2 dB		2x QPSK (3/4)	-92 dBm	± 2 dB
	4x 16QAM (1/2)	22 dBm	± 2 dB		4x 16QAM (1/2)	-90 dBm	± 2 dB
	4x 16QAM (3/4)	22 dBm	± 2 dB		4x 16QAM (3/4)	-86 dBm	± 2 dB
	6x 64QAM (2/3)	22 dBm	± 2 dB		6x 64QAM (2/3)	-83 dBm	± 2 dB
	6x 64QAM (3/4)	21 dBm	± 2 dB		6x 64QAM (3/4)	-77 dBm	± 2 dB
	6x 64QAM (5/6)	20 dBm	± 2 dB		6x 64QAM (5/6)	-74 dBm	± 2 dB
	8x 256QAM (3/4)	18 dBm	± 2 dB		8x 256QAM (3/4)	-69 dBm	± 2 dB
8x 256QAM (5/6)	18 dBm	± 2 dB	8x 256QAM (5/6)	-65 dBm	± 2 dB		

PBE-5AC-500 Antenna Information	
Gain	27 dBi
Max. VSWR	1.5:1
Built-In Mechanical Downtilt	+20° to -10°

Return Loss

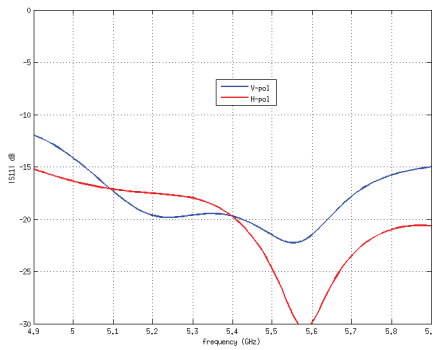

Vertical Azimuth

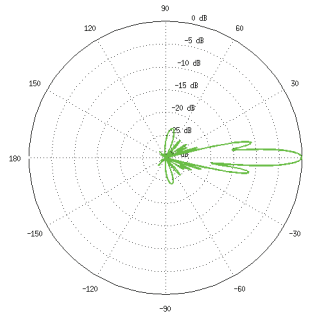

Vertical Elevation

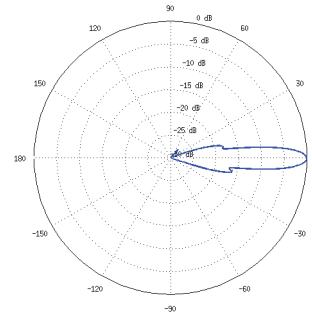

Horizontal Azimuth

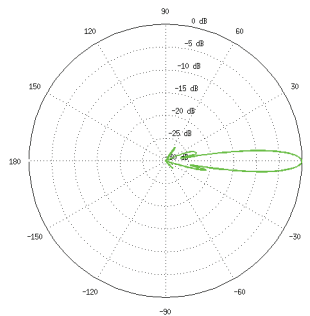

Horizontal Elevation

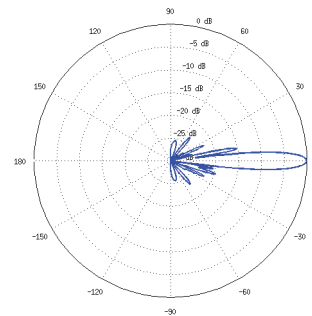

Specifications

PBE-5AC-620 System and Regulatory/Compliance	
Processor Specs	Atheros MIPS 74Kc, 720 MHz
Memory	128 MB DDR2, 8 MB Flash
Networking Interface	(1) 10/100/1000 Ethernet Port
Wireless Approvals	FCC, IC, CE
RoHS Compliance	Yes

PBE-5AC-620 Physical/Electrical/Environmental	
Dimensions	620 x 620 x 386 mm (24.41 x 24.41 x 15.2")
Weight	6.4 kg (14.11 lb)
Power Supply	24V, 0.5A Gigabit PoE
Power Method	Passive PoE (Pairs 4, 5+; 7, 8 Return)
Supported Voltage Range	20-26VDC
Max. Power Consumption	8.5W
Gain	29 dBi
Operating Frequency	
Worldwide	5150 - 5875 MHz
USA	5725 - 5850 MHz
Wind Loading	872 N @200 km/h (196 lbf @125 mph)
Wind Survivability	200 km/h (125 mph)
LEDs	(1) Power, (1) LAN, (4) WLAN
Signal Strength LEDs	Software-Adjustable to Correspond to Custom RSSI Levels
Channel Sizes	
PtP Mode	10/20/30/40/50/60/80 MHz
PtMP Mode	10/20/30/40 MHz
Polarization	Dual Linear
Enclosure	Outdoor UV Stabilized Plastic
Mounting	Pole-Mount Kit Included
ESD/EMP Protection	Air: ± 24 kV, Contact: ± 24 kV
Operating Temperature	-40 to 70° C (-40 to 158° F)
Operating Humidity	5 to 95% Non-Condensing
Salt Fog Test	IEC 68-2-11 (ASTM B117), Equivalent: MIL-STD-810 G Method 509.5
Vibration Test	IEC 68-2-6
Temperature Shock Test	IEC 68-2-14
UV Test	IEC 68-2-5 at 40° C (104° F), Equivalent: ETS 300 019-1-4
Wind-Driven Rain Test	ETS 300 019-1-4, Equivalent: MIL-STD-810 G Method 506.5

Specifications

PBE-5AC-620 Output Power: 24 dBm

TX Power Specifications				RX Power Specifications			
Modulation	Data Rate	Avg. TX	Tolerance	Modulation	Data Rate	Sensitivity	Tolerance
airMAX ac	1x BPSK (1/2)	24 dBm	± 2 dB	airMAX ac	1x BPSK (1/2)	-96 dBm	± 2 dB
	2x QPSK (1/2)	24 dBm	± 2 dB		2x QPSK (1/2)	-95 dBm	± 2 dB
	2x QPSK (3/4)	24 dBm	± 2 dB		2x QPSK (3/4)	-92 dBm	± 2 dB
	4x 16QAM (1/2)	24 dBm	± 2 dB		4x 16QAM (1/2)	-90 dBm	± 2 dB
	4x 16QAM (3/4)	24 dBm	± 2 dB		4x 16QAM (3/4)	-86 dBm	± 2 dB
	6x 64QAM (2/3)	23 dBm	± 2 dB		6x 64QAM (2/3)	-83 dBm	± 2 dB
	6x 64QAM (3/4)	23 dBm	± 2 dB		6x 64QAM (3/4)	-77 dBm	± 2 dB
	6x 64QAM (5/6)	22 dBm	± 2 dB		6x 64QAM (5/6)	-74 dBm	± 2 dB
	8x 256QAM (3/4)	20 dBm	± 2 dB		8x 256QAM (3/4)	-69 dBm	± 2 dB
8x 256QAM (5/6)	20 dBm	± 2 dB	8x 256QAM (5/6)	-65 dBm	± 2 dB		

PBE-5AC-620 Antenna Information

Gain	29 dBi
Max. VSWR	1.6:1
Built-In Mechanical Downtilt	+15° to -15°

Return Loss

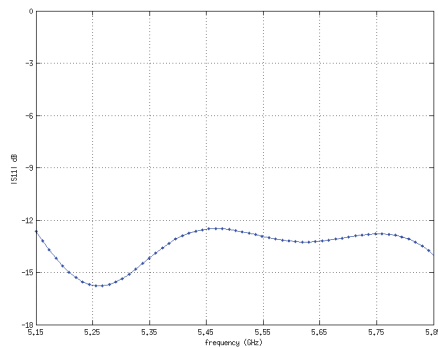

E-Plane

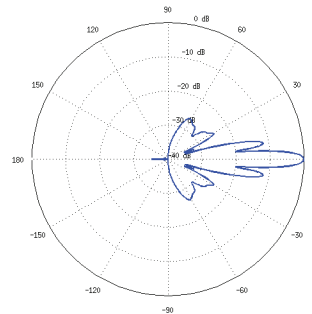

E-Plane Specs

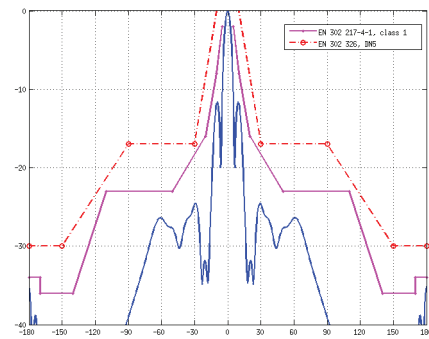

H-Plane

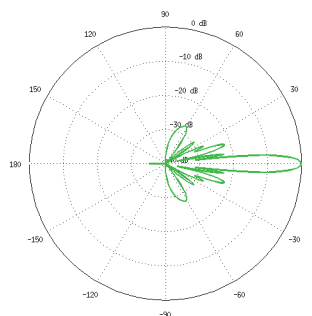

H-Plane Specs

